

DS-1268ZJ

Pendent Mounting Bracket for Dome Camera

Features:

- Aluminum alloy material with surface spray treatment
- Design with cable entry hole

Dimension:

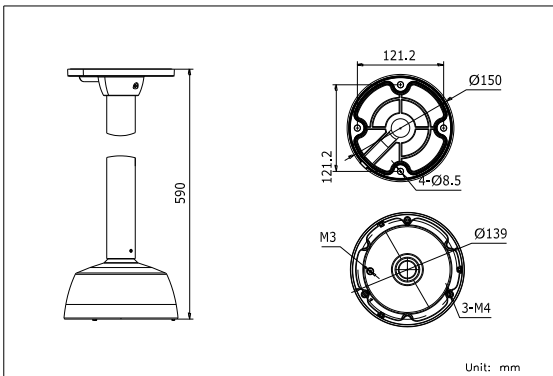

Order Model:

DS-1268ZJ

Parameter:

Model	DS-1268ZJ
Parameters	Pendent Mounting Bracket for Dome Camera
Appearance	Hikvision White
Range of Application	Suitable for dome camera pendent mounting
Material	Aluminum Alloy
Dimension	Φ 139 × 590mm
Weight	2200g



Notice:

- The bracket is for dome camera
- Pay attention to color matching
- The bracket should be installed on flat wall
- The wall must be capable of supporting over 3 times as much as the total weight of the camera and the mount.
- The maximum load capacity of the bracket is 4.5KG

Model Suitable:

DS-2CD72XXF-E(I)Z(H)(S), DS-2CD72X3PF-E(I)Z(H)(S), DS-2CD72X3NF-E(I)Z(H)(S), DS-2CD7293PFW-D-E(I)Z(H)(S), DS-2CD7293NFW-D-E(I)Z(H)(S), DS-2CD72X4FWD-E(I)Z(H)(S), DS-2CD4312F(WD)-(I)Z(H)(S), DS-2CD4324F-(I)Z(H)(S), DS-2CD4332FWD-(I)Z(H)(S)

Installation Step:

① Choose the appropriate wall to fix base, pole and cap; complete wiring

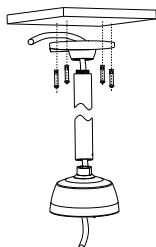

② Complete installation and screw up

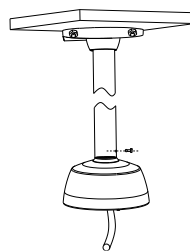

③ Take off lower dome and unscrew the zoom module

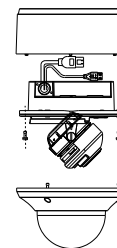

⑤ Wiring and fix zoom module to adaptor and adjust the angle of view

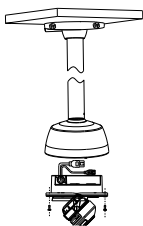

⑥ Unscrew the zoom module and fix the lower dome

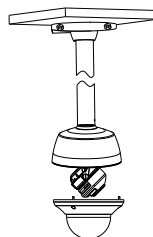

⑦ Installation Complete

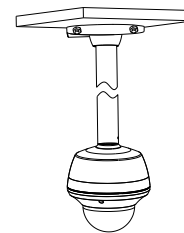

Note: The actual bracket may vary from the picture above.